

K-CIPTM

HANDSCHUHKASTEN

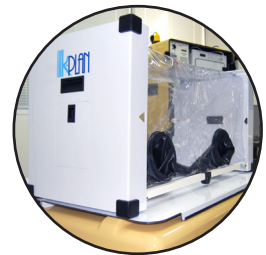

ARBEIT IN VÖLLIG
ISOLIERTER
UMGEBUNG

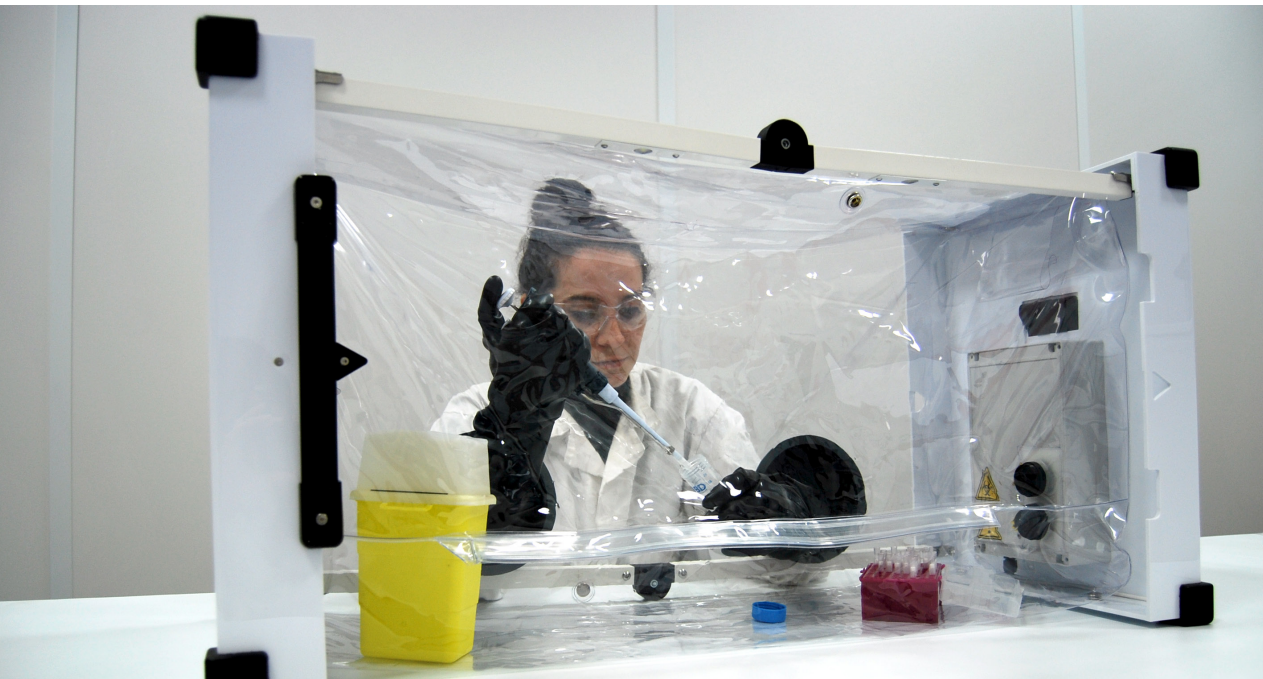
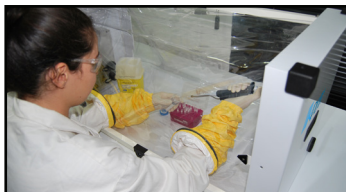
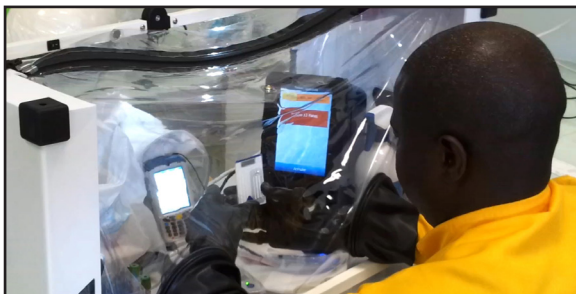

MANIPULATION VON
PROBEN IN VÖLLIGER
SICHERHEIT



UNERREICHTE BEWEGLICHKEIT VERGlichen
MIT ANDEREN PRODUKTEN AUF DEM MARKT



ANWENDUNGSBEREICHE

Menschliche
Gesundheit

Andere Wirtschaftszweige
Chemie / Kosmetik...

K-CIP™

Kriminaltechnik /
Bioterrorismus

Lebensmittelsicherheit

AUSRÜSTUNG

Transportgriff



Stauraum für elektrische Kabel

Beleuchtung mittels LED

Ausklappbarer Arm

Schleuse

Transportmodus

UV-Lampe

Netz

Eingriffssystem
(Passende Handschuhe und Manschetten.)

Verwendungsmodus

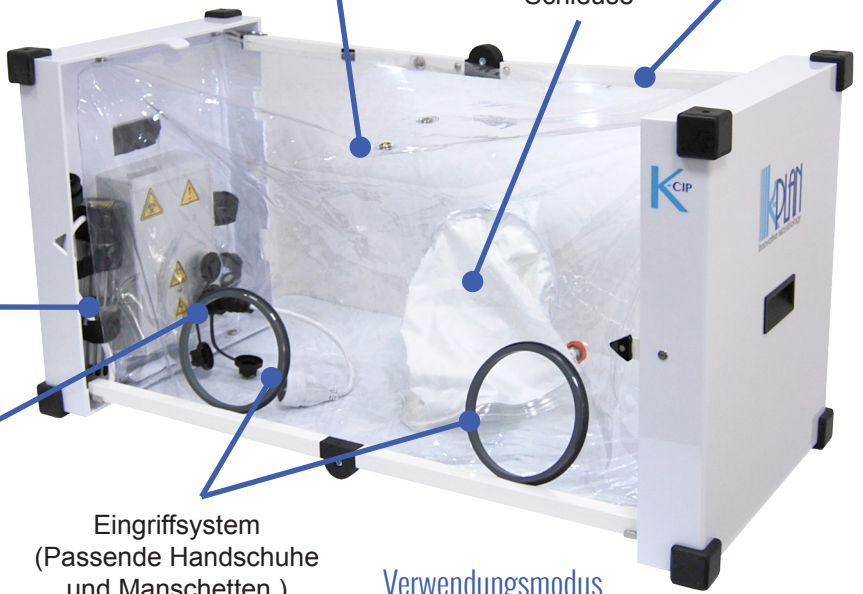

TECHNISCHE EIGENSCHAFTEN

- * Austauschbare hermetische PVC-Zelle
- * Austauschbare hermetische PVC-Zelle
- * Nutzbare Arbeitsfläche:
L 320 x I 830 x H 421 mm

- * LED-Beleuchtung
- * Keimtötende UV-Lampe
- * Interne Steckdose
- * Gewicht: 6kg

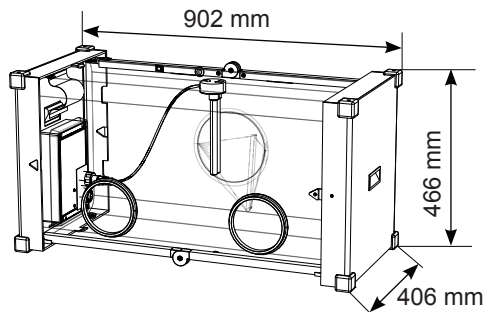
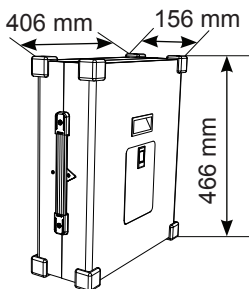

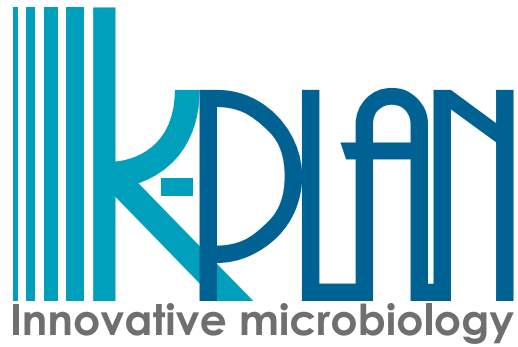

contact@k-plan.fr
www.k-plan.fr

HAUPTSITZ
66 BOULEVARD NIELS BOHR
F-69100 VILLEURBANNE
 **+33 (0) 951 65 04 00**

ABTEILUNG BIOLOGIE
ZONE LUMINY BIOTECH ENTREPRISES - CASE 922
163 AVENUE DE LUMINY F-13288 MARSEILLE CEDEX 09
 **+33 (0) 486 94 85 21**